



Product designation				Motor protection relay
Product type designation				RFE45
General characteristics				
Number of poles	nr.			3
Overvoltage category				III
Pollution degree				3
Frontal IP degree				IP20
Type of release				Electronic thermal
Protection fuse				
	gG (IEC)	A	6 A	
	aM (IEC)	A	4 A	
Phase failure detection				YES
Reset mode				Manual or automatic
Power circuit characteristics				
Operating frequency				
	Operational frequency max	Hz	60 1/s	
Operating current				
	Operational current min	A	0.4 A	
	Operational current max	A	2 A	
Tripping class				5 - 10 - 20 - 30
Test Button				YES
Trip indicator				YES
Terminals				
	type	Screw and washer		
	screw	M4		
	tool	Phillips 2		
Conductor section				
	AWG max	6		
Auxiliary circuit characteristics				
Auxiliary contacts				
	NO	nr.	1	
	NC	nr.	1	
Operating current AC15				
	24V	A	3 A	
	120V	A	3 A	
	240V	A	1.5 A	
	380V	A	0.95 A	
	480V	A	0.75 A	
	500V	A	0.72 A	
	600V	A	0.6 A	
Operating current DC13				

	125V	A	0.11 A
	600V	A	0.22 A
Conventional free air thermal current I _{th}		A	10 A

Terminals

type	Screw and washer
screw	M3,5
tool	Phillips 2

UL/CSA and IEC/EN 60947-5-1 designation	B600-R300
---	-----------

Ambient conditions

Max altitude	m	3000
--------------	---	------

Mechanical features

Operating position	normal allowable	Vertical plan ±30°
--------------------	------------------	--------------------

Weight	g	0.195 kg
--------	---	----------

UL technical data

Full-load current (FLA) for three-phase AC motor	at 480V	A	2 A
	at 600V	A	2 A

Dimensions

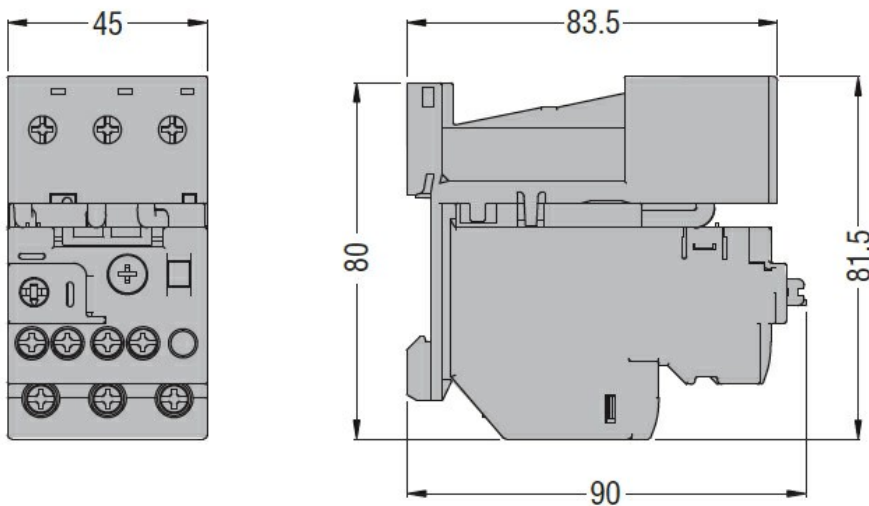

Wiring diagrams

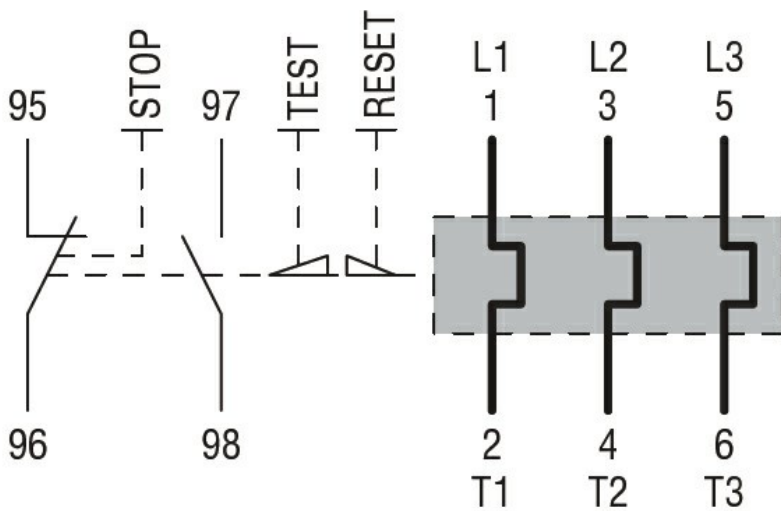

Certifications and compliance

Compliance

CSA C22.2 n° 60947-1

CSA C22.2 n° 60947-4-1

IEC/EN 60947-1; IEC/EN 60947-4-1

UL 60947-1

UL 60947-4-1

Certifications

cULus